

The importance of standards in the EdTech ecosystem

Géant Education Task Force January 7, 2021

Wietze de Vries - Sunet

Michael Webb - Jisc

Jasmijn Wijn - SURF

Nynke de Boer - IMS Global

Markus Gylling - IMS Global

We'll always have Budapest

November 2019



©Gatty





Agenda

14:05 - Presentation

14:20 - Reflection in breakout groups

14:35 - Central discussion

14:45 - Interviews with Sunet, SURF and JISC

15:00 - Reflection in breakout groups

15:15 - Central discussion



EDTECH ECOSYSTEM 2020



?

Flexibility
Data Governance
Accessibility
Interoperability
Exchangeability



Let's..

- Agree
- Specify
- Standardize
- Regulate?
- ...



Stakeholders

- Vendors
- Schools and Universities
- Governments
- Publishers
- Students
- ...



Bringing it all together



IMS Europe community



Direktoratet for e-Helse

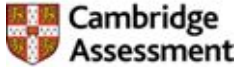

Insendi



Asociacion Chamilo



Talis Education Ltd

College voor Toetsen en Examens

Eindhoven

University of Technology

Let's Hub

DRiEAM

FutureLearn

NAVIGATR

Learnosity

Calibrand Limited

Citrus Andriessen

Cornelsen

iqc

Realizei Vereniging

Jisc

Kennisnet

Aula Education Ltd.

Limited e-Learning WMB



University of Southampto

Hogescolen

Conexus AS

Joubel AS

Ladok

Oxford University

ORACLE

its Learning

Tutteo

ITWorx Education

Reiss Romoli srl



PebblePad

Cineca

Practice Labs



Edudevel Solutions S.L.

BCdiploma

SAM Labs Inc.

moodle

tao

SANTILLANA

SURF

EUNIS

TRIFORK

Open Badge Factory

ReadSpeaker

BPS Bildungsportal

University of St. Andrews

Erasmus



Norwegian Directorate for Education and Training

UNINETT

Sachsen GmbH

VitalSource

xquiry

Universiteit

National Foundation



Universiteit

educational data forensics

Rotterdam

National Foundation



Electric Paper



van

CDSM

Blackboard for Educational

Evaluationsystem

Amsterdam



Vigilo

MyKnowledgeMap

Research

e GmbH

Ulearn Education Ltd.IS

Limited

Studia EHF

Vetenskapsrådet

Masterplan.com GmbH

@Learningimpact | imsglobal.org

© 2020 IMS Global Learning Consortium, Inc. All rights reserved.



IMS Europe community



Eindhoven
University of
Technology

University of
Southampton



University of Glasgow



University of St. Andrews

Erasmus
Universiteit
Rotterdam



Universiteit
van
Amsterdam



Vetenskapsrådet

@Learningimpact | imglobal.org

© 2020 IMS Global Learning Consortium, Inc. All rights reserved.



The IMS edtech standards

- LTI - integrates remote tools and content into your edtech ecosystem
- Open Badges - describes a method for packaging information about accomplishments
- Caliper Analytics - enables to collect learning data from digital resources
- Edu-API - combines data from the Student Information System (SIS) together with data from learning platforms
- QTI - enables high quality interoperable digital assessment, both summative and formative.
- many more...

Other initiative:

- App Vetting - helps to select digital resources that have been vetted for privacy and security.

IMS Global - IMS Europe

The supporting organization

- 20+ years
- 30 peopl, of which 4 in Europe
- Supports the IMS community
 - Technical support
 - Documenting
 - Certification
 - Support technical meetings
 - Summits
 - Trend watchers
 - Connectors
 - ..





NAP



High water Rhine at Lobith: 14,65 over NAP on January 7, 2018



Low water Rhine at Lobith: 6,73 over NAP on October 18, 2018



NAP = Normaal Amsterdams Peil

Average high water mark of the North Sea, measured in Amsterdam

Year	
1683	Finalized for the region of Amsterdam
1860	In use for the whole country
1879	in use by Germany and Luxembourg
1973	In use by Sweden, Norway and Finland
2007	NAP is basis for EVRS (European Vertical Reference System)
Assist other countries (Japan) with setting up a water level system	



Hochrheinbrücke Laufenburg 2004



LEGO



IKEA

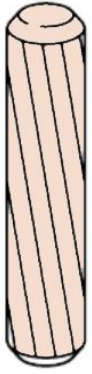

101351

16x

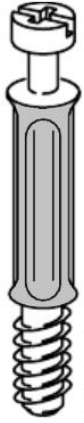

112996

12x

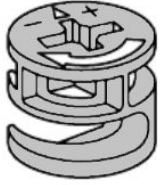

113434

12x

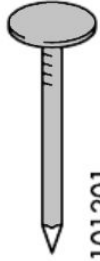

101201

18x

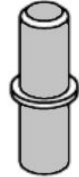

101532

16x



IEC 60086

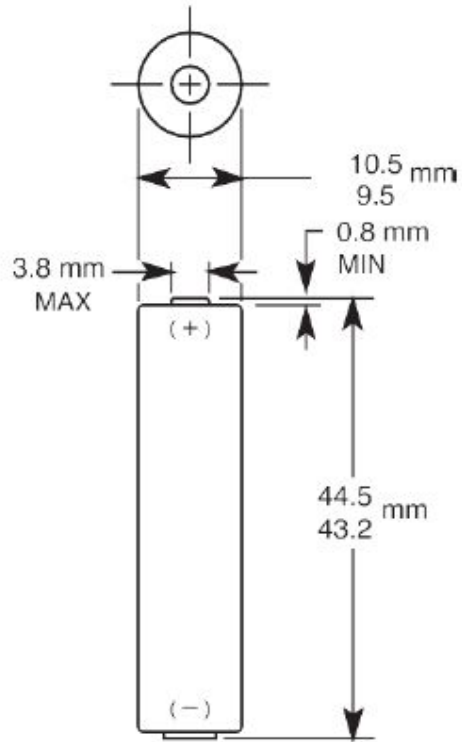

Handy woman Ecosystem



1/4"-hex

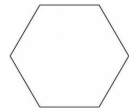

1/4"-hex



Machinery



Standard....





IMS EDTECH ECOSYSTEM

Standards and more

- Flexibility
- Exchangeability
- Interoperability
- Open
- Data Governance
- Accessibility
- Open
- Stakeholders
- Collaboration

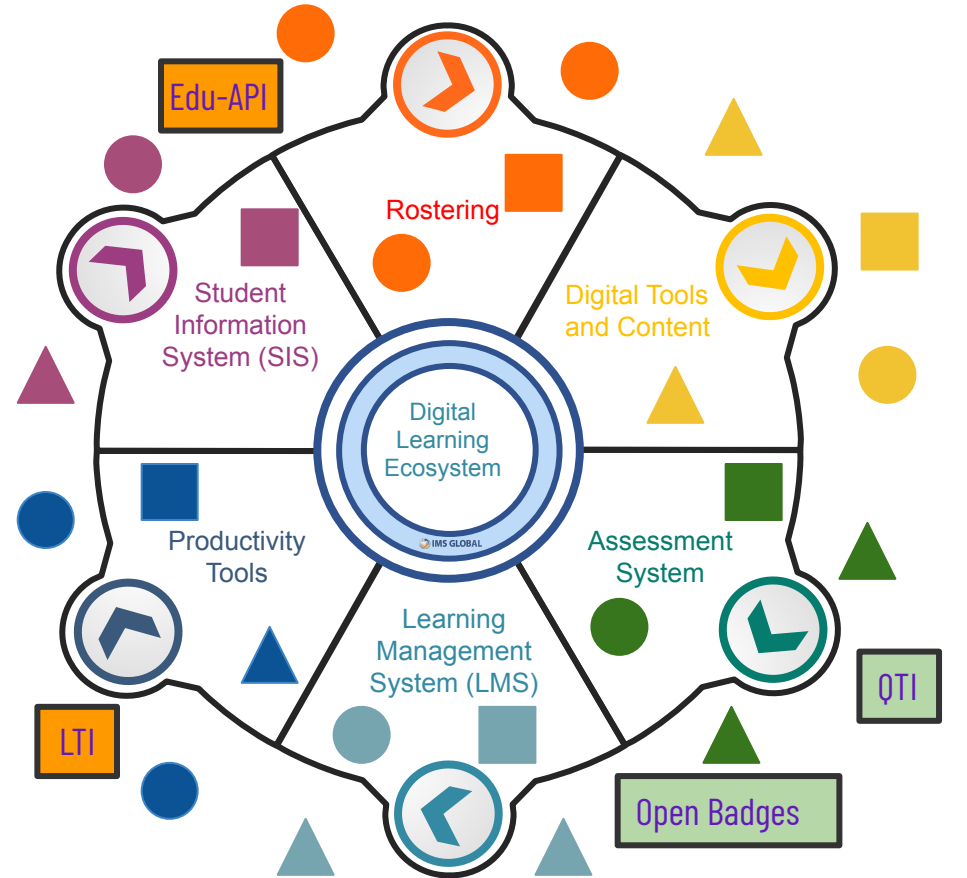

Collaboration - IMS Europe community



Direktoratet for e-Helse

Insendi

Asociacion Chamilo

Eindhoven

Let's Hub

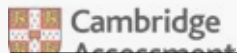

Talis Education Ltd

University of Technology

DRREAM

IMS Europe Technical Task Force



- GDPR extension LTI
- European profile OneRoster
- ...

IMS Europe Leadership Board



- Vision and priorities
- Raise awareness
- Summit and other meetings

European Edu-API Task Force



- Add European perspective to Global Edu-API working group

Electric Paper Evaluationssystem e GmbH

Ulearn Education Ltd.IS



Blackboard for Educational

MyKnowledgeMap Limited

Research Studio EHF

Vetenskapsrådet

Masterplan.com GmbH

@Learningimpact | imsglobal.org

© 2020 IMS Global Learning Consortium, Inc. All rights reserved.



Sources of Information

- The IMS website:
<https://www.imsglobal.org>
- New series of 5-minute duration videos on IMS specifications:
<https://www.youtube.com/playlist?list=PLysC4Zd9-FmD773cUYratfgiwBtLGr7Jb>
- Answers to questions raised in Géant meeting in Budapest in November 2019:
https://docs.google.com/document/d/1arwJirmVEhp-dGs8Ev1MTn_QU1lO1FAYlrv0_4zTxs/edit
- European information document on IMS Global:
https://www.imsglobal.org/sites/default/files/EUsummit2020/IMS_Europe_Overview_May2020.pdf

Sources of Information (2)

- Markus Gylling - mgylling@imglobal.org
- Nynke de Boer - ndeboer@imglobal.org

Get Involved !

Help Build the IMS Ecosystems